

**SPARK PLUGS**









Part#	Champion#	Bosch	NGK	Nippondenso	Autolite	AC	Application
<b>690-300</b>	CJ7Y	WS8F	BPM7A	W22MP-U	2974	CS42S	Alpina, Caster, Dynamark, Husqvarna, Jonsereds, Lombard, Olympyk, Solo - saws
<b>690-301</b>	J19LM	W9EO	B2-LM	W14LM-U	458	----	Newer Briggs & Tecumseh
<b>690-302</b>	CJ8 / CJ11	WS8E	BM6A	W20M-U	2995	CS41	Briggs, Echo, Poulan
<b>690-303</b>	RC12YC	FR8DC	BCPR5ES	Q16PR-U11	5224	FR2LSK	Briggs Vanguard and Kohler Command
<b>690-304</b>	DJ8J	HS8E	BM6F	WA20M-U	2956	CS45T	Homelite, McCulloch & others
<b>690-305</b>	RJ19LM	W7AC	BR2-LM	W14LM-U	414	----	Briggs and Tecumseh
<b>690-306</b>	RCJ8	----	BMR6A BMR4A	W20MR-U	245	----	Fits most single cylinder Briggs & Kawasaki 12.5 Hp
<b>690-307</b>	RCJ6Y	WSR5F	BPMR7A	W22MP-U	----	----	Resistor plug for Tecumseh TC300
<b>690-308</b>	CJ6 / CJ4	WS7E	BM7A	W22M-U	254	CS40	For Chain Saws & Trimmers
<b>690-309</b>	CJ8Y	WS7F	BPM6A	W20MP-U	2976	----	Echo, John Deere and others.
<b>690-310</b>	N11YC	W8DC	BP5ES	W16EP-U	54	----	Honda GVX120 and GSX270
<b>690-311</b>	CJ6Y	WS5F	BPM7A	W22MP-U	----	----	Kawasaki TEX54 and Tecumseh TCH300
<b>690-312</b>	RN9YC	----	BPR6ES	W20ETR-S	3923	----	Honda OHC Horiz. & vert., Robin 8.5 thru 25 Hp EH & EHV
<b>690-313</b>	J17LM	W9ECO	B4LM	W14LM-U	295	----	Tecumseh HM70 thru HM100 AV520, AV600, TC300
<b>690-314</b>	RN11YC4	WR8DS	BPR5ES	W16EPR-U W16EXR-U	54	----	Honda OHV GX120 - 670 and GVX50 - 620, Kawasaki OHV - FC150V, FC180V and others.
<b>690-315</b>	N9YC	W6D	BP6ES	W20EX-U	4253	----	Honda OHV Horiz. & vert Robin 8.5 thru 25 Hp EH & EHV
<b>690-316</b>	DJ6J	HS5E	BM7F	T22MU	2954	----	Homelite Mini models, Super E-Z & EZ-AO, McCulloch 5-10A, MAC 10 series & others.
<b>690-317</b>	J8C	W8E	B6S	W16S-U	294	----	Tecumseh HH100, HH120, HH60, HH70, HH80 and others.
<b>690-318</b>	DJ7Y	HS8E	BPM6F	WA20M-U	2956	----	Homelite 180, 192, 200 all models, CS40, DM40, LX30, McCulloch Eager
<b>690-319</b>	RCJ8Y	----	BPMR4A	W14PR-UID	----	----	Tecumseh Horiz. 2-cycle, Snow King up to 5 Hp & others.
<b>690-320</b>	RL95YC	W8B	BP4HS	W16FPU	516	----	Honda 10 Hp G400
<b>690-321</b>	L86C	W8A	B6HS	W22FSU	415	----	Honda 4.0, 40, G40, G41, G42, 6.5 Hp G65, GS65, Wisconsin OHV, Tecumseh OVM 120.
<b>690-323</b>	N2C	W2C	B8ES	W22ESL	2616 (NZC)	---	Snowmobile - Ski Doo, Yamaha
<b>690-324</b>	RCJ7Y	WSR9E	BPMR4A	W14MPR-410	----	----	Alpina, Castor, Noma/Dynamark Husqvarna, Jonsereds, Solo, Lombard, Olympyk, Oleo-Mac Chain Saws

**NEW**

**UNIVERSAL**

Part#	OEM#	Application	
<b>751-222</b>	MTD# 725-0119 Noma# 39463	<b>Universal Ammeter</b> - 15 amp gauge that can be used with 6, 12 or 24 volt equipment. Used on many Riders and Lawn Tractors. OEM style with a quality chrome bezel. Includes: mounting bracket and hardware.	

Part#	Length	Colour	Stud Size	Application	
<b>425-041</b>	8"	Black	5/16", 3/8"	<b>Battery Cables</b> - 300 volt, 6 gauge "all copper conductor" cable. Poly-vinyl insulation Resistant to grease, oil and gasoline. Heavy duty - corrosion resistant terminal ends.	
<b>425-215</b>	8"	Red	5/16", 3/8"		
<b>425-058</b>	12"	Black	5/16", 3/8"		
<b>425-223</b>	12"	Red	5/16", 3/8"		
<b>425-066</b>	16"	Black	5/16", 3/8"		
<b>425-231</b>	16"	Red	5/16", 3/8"		
<b>425-074</b>	20"	Black	5/16", 3/8"		
<b>425-249</b>	20"	Red	5/16", 3/8"	<b>Battery Cable (10 FT)</b> - 300 volt, 6 gauge "all copper conductor" cable. Poly-vinyl insulation Resistant to grease, oil, gasoline.	
<b>425-033</b>	10 ft	Black	6 gauge		
<b>425-264</b>	10 ft	Red	6 gauge		

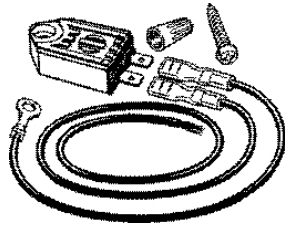
Part#	Size	Application	
<b>425-124</b>	1/4"	<b>Battery Terminal Ends</b> - Lead dipped for corrosion resistance. Open conductive brass lugs. For 6 - 2 gauge battery cable. Use with our 425-033 and 425-264 6 gauge battery cable. <small>(Sold in multiples of 10)</small>	
<b>425-207</b>	3/8"		
<b>425-116</b>	Universal	<b>Universal Battery Terminal</b> - Fits 6 thru 2 gauge battery cable. Universal lead terminal will fit all top post batteries.	
<b>425-039</b>	<b>Universal Battery Hold Downs</b> - Includes: bolt, washer & wing nut. Overall Length: 8", threaded 4-1/2". Use with our 425-038 "Universal adjustable battery hold downs". (Priced and Sold in sets)		
<b>425-038</b>	<b>Universal Adjustable Battery Hold Downs</b> - Use with our 425-039 "Battery hold down bolt". (Priced and Sold in sets)		
<b>440-065</b>	<b>NOVA IGNITION MODULE</b> - Already in use by O.E.M.'s as standard ignition in their units. Maintenance free / easily installed / quick and easy starting. Operates well in any weather conditions and completely waterproof. Highly reliable / durable construction / high performance. Anti-kickback system / die cast aluminum housing. Widely used in 2 and 4 cycle gasoline engines as in Lawnmowers, generators, pumps, cultivators, tillers, compact garden tractors, chain saws, brushcutters, dusters, trimmers, go-carts, blowers etc. The NOVA module is suitable for 2 leg and 3 leg ignition coils in single cylinder engines. This module is not recommended for use on engines equipped with battery ignition or flywheels with multiple magnets.		

**ATOM IGNITION MODULES / MINI-TRONS**

Part#	OEM#	Application
440-205	AM-205	<b>Green Mini-tron</b> - Fits all single cylinder Briggs and Stratton engines as used in Lawnmowers, cultivators, pumps, generators, snowblowers, Ride-on Mowers, compact garden tractors, etc. Also replaces magnetron transistor ignition. (For twin cylinder Briggs engines use our 440-209 module.)
440-207	AM-207	<b>Blue Mini-tron</b> - Fits Outdoor Power Equipment engines as used in Lawnmowers, cultivators, misting machines, pumps, generators, snowblowers, shredders, compact garden tractors, etc. (Exceptions: some Tecumseh engines fitted with cast iron flywheels, some JLO engines, Honda GV150, GV200, G50). Fits all VICTA engines (except twin - which uses our 440-209 module.)
440-209	AM-209	<b>Brown Mini-tron</b> - Fits Chain Saws, Brushcutters, String Trimmers, Hedge Trimmers - All mechanical points equipped. Also replaces transistor modules on String Trimmers (prevents excessive RPM). Fits twin cylinder Briggs and Stratton, Victa Twin, Kawasaki KF100 and KF200.
440-215	AM-215	<b>Red Mini-tron</b> - Fits Twin cylinder Outboard motors (using one module per cylinder). Not for engines with battery generator flywheels. Also fits single cylinder outboards with throttle connected ignition timing. For outboards with fixed ignition timing refer to our 440-007 module.
440-214	AM-214	<b>Yellow Mini-tron</b> - Replaces Transistor ignition modules as fitted to many Chain Saws.
440-007	AM-007	<b>Purple Mini-tron</b> - Fits Outboard motors with fixed ignition timing. (One module per cylinder).
440-009	AM-009	<b>Pink Mini-tron</b> - Fits most Mopeds, trailbikes & motorcycles. (Magnetic ignition - not battery ignitions).

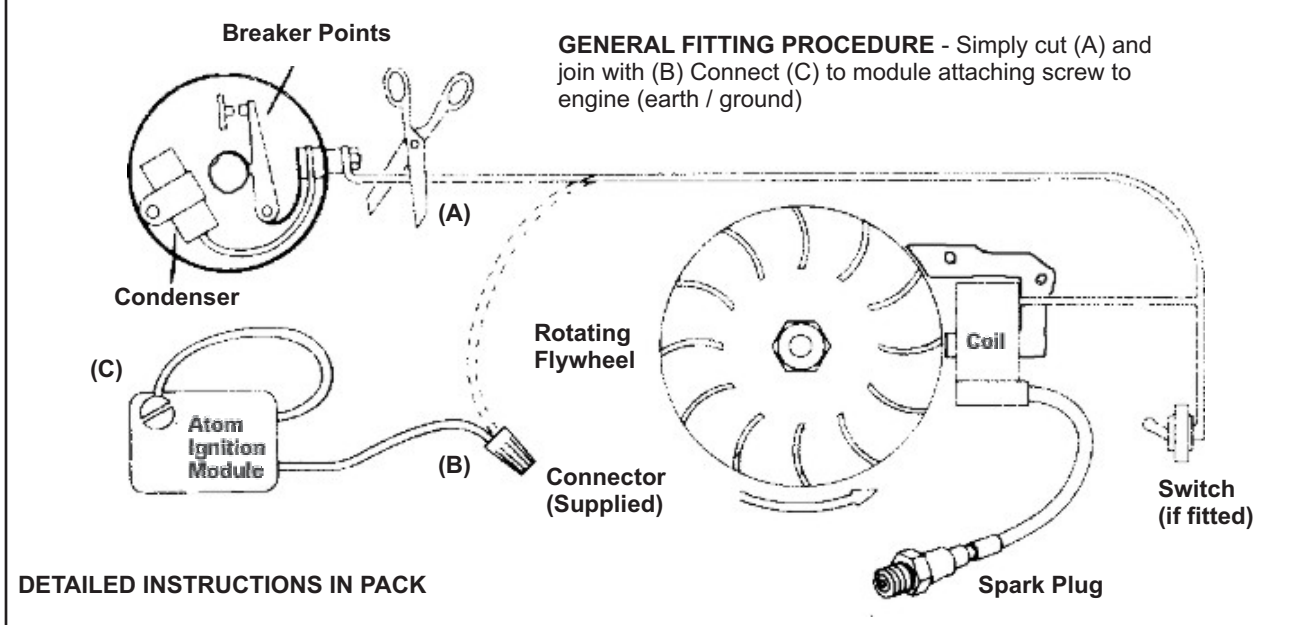
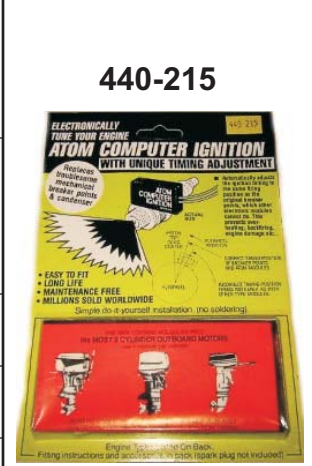







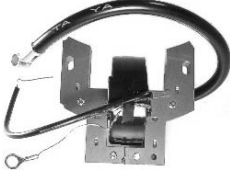
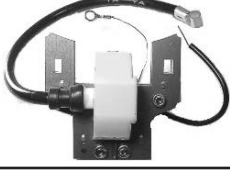

**DETAILED INSTRUCTIONS IN PACK**

**HOW IT WORKS:**





1. When starting the engine, the kick-back prevention mode prevents spark occurring until the required engine RPM is achieved (safety feature)
2. When engine is operating, at speed or under load, the timing adjustment mode produces the ignition spark firing position at the same efficiency gap position as the points and condenser.

(Other types of modules cannot do this as they are similar to those used for factory fitted engines which to ensure correct ignition timing, the factory alters their flywheel keyway position.)

## COILS / ELECTRONIC MODULES





Part#	OEM#	Application	
<b>460-014</b>	B&S# 298502 B&S# 395488 John Deere# AM30950	<b>Briggs Ignition Coil</b> - Fits most 2 thru 4 Hp engines with breaker point ignitions. Models 60100 thru 60497, 81500 thru 81997, 82500 thru 85902, 92500 thru 95500 and 110900 thru 113900. (For electronic ignition module, use our 440-409)	
<b>460-030</b>	B&S# 298316	<b>Briggs Ignition Coil</b> - Fits most 5 Hp engines with breaker point ignitions. Models 100200, 100900 and 130200 thru 132900. (For electronic ignition, use our 440-401)	
<b>460-006</b>	B&S# 298968 B&S# 299366 John Deere# AM35759	<b>Briggs Ignition Coil</b> - Fits most 7 thru 16 Hp engines with breaker point ignitions. Models 144200 thru 147707, 170400 thru 253400 and 300400 thru 326400. (For electronic ignition, use our 440-417)	
<b>460-022</b>	B&S# 290880	<b>Briggs Ignition Coil</b> - Fits models 9, 14, 19, 23, 23A and 191400 thru 231400.	
<b>440-409</b>	B&S# 398593 B&S# 496914 John Deere# PT11047	<b>Briggs Electronic Module</b> - For most 2 thru 4 Hp vertical and horizontal engines with electronic ignitions.	
<b>440-401</b>	B&S# 397358 B&S# 395491 John Deere# PT10998	<b>Briggs Electronic Module</b> - Fits 5 Hp vertical and horizontal engines with electronic ignitions - except for Quantum engines. Fits models 133200, 133700, 135200 and 135700.	
<b>440-433</b>	B&S# 802574	<b>Briggs Electronic Module</b> - Fits Quantum and Europa engines. Models 96700 (2-cycle), 96900, 99700, 12A800 - 12W800 and 121600 - 129800.	
<b>440-417</b>	B&S# 398811 B&S# 395492 B&S# 398265 John Deere# PT15339	<b>Briggs Electronic Module</b> - Fits 7 thru 16 Hp vertical and horizontal single cylinder engines with electronic ignitions. Fits models 176432, 192400, 196400, 197400, 19E400, 19G400, 226400 and 250400.	
NOTE: Use our 440-441 after code# 80090600			
<b>440-441</b>	B&S# 492341 B&S# 491312 B&S# 490586	<b>Briggs Electronic Module</b> - Fits 10 thru 13 Hp L-head engine and Vanguard models 9 Hp, 12-1/2 Hp and 14 Hp. Fits models 286702, 286707, 28B702, 28B707 and 28C707.	
NOTE: Use our 440-417 before code# 80090600			

**COILS / ELECTRONIC MODULES continued**











Part#	OEM#	Application	
<b>440-425</b>	B&S# 394891	<b>Briggs Electronic Module</b> - Fits 16 thru 18 Hp vertical and horizontal twin cylinder L-head engines with electronic ignition. Models from 400400 thru 422700.	
<b>460-052</b> <b>NEW</b>	B&S# 691060	<b>Briggs Ignition Coil</b> - For Intek V-Twin engines.	
<b>460-053</b> <b>NEW</b>	B&S# 695711	<b>Briggs Ignition Coil</b> - For 11 and 12 CID Intek engines.	
<b>440-216</b> 	B&S# 394970 B&S# 395025 B&S# 5025	<b>Briggs Electronic</b> - Fits all engines since 1983 with 2 leg coils except 9, 10 and 16 Hp cast iron engines or twin cylinder engines. Fits our 460-006, 460-014 and 460-030 coils.	

**For Dolmar / Sachs / Makita - see our "CHAIN SAW ACCESSORIES- O.E.M." section.**

**For Homelite & Husqvarna - see our "CHAIN SAW" and "TRIMMER" sections.**

<b>440-348</b>	Honda# 30500-ZE1-033 Code# 4589693	<b>Honda Ignition Coil</b> - (Solid state module) Fits models GX110, GX120, GX140 and GX160.	
<b>440-342</b> <b>NEW</b>	Honda# 30500-ZG9-M02 Code# 4581476	<b>Honda Ignition Coil</b> Fits most GXV120 series engines.	
<b>440-340</b> <b>NEW</b>	Honda# 30500-ZE7-043 30500-ZE7-033 30500-ZG9-801 Code# 7199227	<b>Honda Ignition Coil</b> Fits most GXV160 series engines.	
<b>440-349</b>	Honda# 30500-ZE2-013 30500-ZF6-W02 Code# 7032428	<b>Honda Ignition Coil</b> - (Solid state module) For magneto ignition. Fits models GX240, GX340 and GX390.	
<b>440-341</b> <b>NEW</b>	Honda# 30500-ZE2-023 30500-ZF6-W02 Code# 7032428	<b>Honda Ignition Coil</b> Fit most GXV240, GXV270, GXV340 and GXV390 series engines.	

**COILS / ELECTRONIC MODULES continued**







<b>Part#</b>	<b>OEM#</b>	<b>Application</b>	
<b>440-517</b> <b>NEW</b>	Kawasaki# 21171-2092 21171-2193 Kaaz# 21130-2056	<b>Kawasaki Magneto Coil</b> - Fits Kawasaki model TD40, TD43 and TD48, also fits Kaaz 32cc and 33cc engines.	
<b>460-071</b>	Kohler# 220435 Phelon# FG-02145	<b>Kohler Coil</b> - Fits model K91 - 4 Hp engines).	
<b>460-048</b>	Kohler# 231281 Tecumseh# 32080	<b>Kohler Ignition Coil</b> - Fits model K91, K141, K181, K241, K301, K321, K341 and K361 engines. For 4, 6, 8, 10, 12 and 14 Hp engines.	
<b>440-518</b> <b>NEW</b>	Kohler# 24-584-15-S Kohler# 24-584-11-S Kohler# 24-584-03	<b>Kohler Ignition Coil</b> - Fits Command series engine models CH20, CH22, CH25, CV22, CV25, CH22S, CH25S and CV22S. 20Hp thru 25 Hp model engines.	
<b>440-519</b> <b>NEW</b>	Kohler# 52-584-02-S	<b>Kohler Ignition Coil</b> - Fits models M18 thru M20, 18 Hp thru 20 Hp model engines.	
<b>460-055</b>	Lawn Boy# 582396 Lawn Boy# 580184 Lawn Boy# 582463 OMC# 582995 / 582931 OMC# 582370 / 580416 OMC# 580197 / 580118	<b>Lawn Boy / OMC Coil</b> - Fits Iron Horse and "C" series Lawnmower models as well as many older Outboard Motors. <b>Note: High tension pin is threaded on this coil, green in colour. (Made in Germany)</b>	
<b>460-097</b>	Lawn Boy# 678539	<b>Lawn Boy Coil</b> - Fits "D" series engines with breaker point ignitions.	
<b>440-040</b>	Lawn Boy# 682340 Lawn Boy# 681578	<b>Lawn Boy Solid State Module</b> - Fits models from 1978 thru 1982 (older "F" series) - grounded to run, - white in colour. Measures: 3-1/4" L X 2-1/2" W X 1-5/8" HT	
<b>440-073</b>	Lawn Boy# 683080 Lawn Boy# 683215 Lawn Boy# 682702 John Deere# PT7176	<b>Lawn Boy Solid State Module</b> - Fits models from 1983 and newer (newer "F" series) - open to run, - gray in colour. Measures: 3-1/4" L X 2-1/2" W X 1-5/8" HT	
<b>440-057</b>	Lawn Boy# 681542 Lawn Boy# 683321	<b>Lawn Boy Solid State Module</b> - Fits D-600 models from 1972 thru 1977. - open to run, - white in colour Measures: 4-1/4" L X 2-1/2" W X 1-3/8" HT	

**COILS / ELECTRONIC MODULES**

Part#	OEM#	Application	
<b>440-059</b>	Lawn Boy# 684048 Lawn Boy# 684049	<b>Lawn Boy Solid State Module</b> - Fits Gold & Silver series.	

**For other Lawn Boy - ELECTRICAL / IGNITION parts see our "TRIMMER" sections**



**For McCulloch, Oleo Mac, Pioneer, Poulan / Weedeater, Ryan, Stihl etc. - see our "CHAIN SAW ACCESSORIES - O.E.M" and "TRIMMER" sections.**

<b>440-524</b> <b>NEW</b>	Robin# EY-15	<b>Robin Ignition Coil</b> - For EY-15 model engines.	
<b>440-525</b> <b>NEW</b>	Robin# EY-20	<b>Robin Ignition Coil</b> - For EY-20 model engines.	
<b>460-063</b>	Tecumseh# 30560A JD# AM30546 JD# 30950 Phelon# FG-6240	<b>Tecumseh Coil</b> - Fits most 3 thru 10 Hp models. Found on LAV, V, H, HS and VM series. - plug wire length: 17" - no lamination Fits most point ignition engines.	
<b>460-048</b>	Tecumseh# 32080 J-Deere# AM38411 Kohler# 231281	<b>Tecumseh Coil</b> - Fits 6 thru 16 Hp engines. Single cylinder engines with battery ignition.	
<b>440-092</b>	Tecumseh# 35135 Tecumseh# 35135A	<b>Tecumseh Electronic Module</b> - Fits models TVM, TVXL170 thru 220, OVXL170 thru 220, OVXL120, HM70 thru HM100, OHM-OHSK120. For 7 thru 12 Hp engines. Medium frame engines.	
<b>440-093</b>	Tecumseh# 34443A Tecumseh# 34443B Tecumseh# 34443C John Deere# PT9567	<b>Tecumseh Electronic Module</b> - Fits models TVS, 90, 100, 105, 115, 120, TNT, 100, 120, ECV 100, 120, H30 thru 70, AH600, HSK600, HXL840, HSK840, HSK845, HSK850, LEV100, LEV115, TVXL105 and TVXL840. Small frame engines.	

**DIODES / HARNESSSES**

<b>435-115</b>	B&S# 393814	<b>Briggs Diode Assembly</b> - Fits 6 thru 20 Hp electric start models.	
<b>435-116</b>	B&S# 393422 B&S# 692306	<b>Briggs Harness</b> - Use with our 435-115 diode assy.	









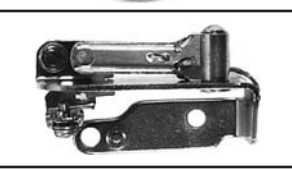

**DIODES / HARNESSSES continued**

Part#	OEM#	Application	
<b>435-205</b>	B&S# 392606 B&S# 691955	<b>Briggs Diode Assembly</b> - For 5 AMP tri-circuit harness alternators. Models 256400, 280700 and 351700 series. Fits Briggs 6 AMP diodes instead of OEM 3 AMP.	
<b>435-206</b>	B&S# 393456	<b>Briggs Diode Assembly</b> - For 2-4 AMP dual circuit alternators. Fits models 196432, 196437, 196452, 197400, 197412, 197417, 280700, 28B700 and 28C700. Fits Briggs 6 AMP diodes instead of OEM 3 AMP.	
<b>435-420</b>	Tecumseh# 611161	<b>Tecumseh Diode Assembly</b> - Fits models HM80, HM100, OHM920, OHV12, OHV125, OVM120 and OVXL125. Measures: 3-1/2" overall length.	



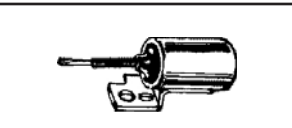





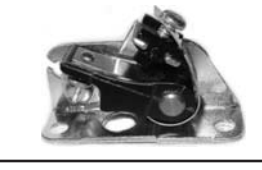

**FLYWHEEL KEYS - (Flywheel Keys are "Sold in multiples of 10)**

<b>445-064</b>	B&S# 222698 B&S# 222698S John Deere# PT7211	<b>Briggs Flywheel Keys</b> - Used on engines with electronic ignitions.	
<b>445-007</b>	B&S# 61760	<b>Briggs Flywheel Keys</b> - Used on engines with breaker point ignitions.	
<b>445-023</b>	Clinton# 148-4	<b>Clinton Flywheel Keys</b>	
<b>445-072</b>	Lawn Boy# 607199 John Deere# 26H10	<b>Lawn Boy Flywheel Key</b> - Fits all LB 2 cycle Lawnmowers with breaker point ignitions. Indent in side holes hold in place on crankshaft. Size: 5/8" L X 5/32" W	
<b>445-015</b>	Tecumseh# 27902	<b>Tecumseh Flywheel Key</b> - Steel flywheel key Size: 1" L X 3/16" W X 1/8" HT	
<b>445-049</b>	Tecumseh# 610961 Tecumseh# 27247 John Deere# M81575	<b>Tecumseh Flywheel Key</b> - For points ignitions on older 3 and 3-1/2 Hp engines. Size: .703" L X .187" W X .125" HT, with a .088" notch depth.	
<b>445-056</b>	Tecumseh# 610951	<b>Tecumseh Flywheel Key</b> - Same as above with only one difference, the notch depth is .054"	
<b>445-052</b>	Tecumseh# 610995 (Silver Key)	<b>Tecumseh Flywheel Key</b> - For points ignitions on newer 3 and 3-1/2 Hp engines with external coils.	
<b>445-405</b>	Tecumseh# 611154	<b>Tecumseh Flywheel Key</b> - Vector series engines. Fits models ULT50, 55, 60, VLV126, 50, 55, 60, 65, 66, VLT150 and VLX155. Size: 31/32" L X 1/8" W X 5/64" HT	
<b>445-403</b>	Tecumseh# 611004 (Gold Key)	<b>Tecumseh Flywheel Key</b> - Offset key used on engines with solid state ignitions. Fits models TVS, TNT, ECV, H30 thru H70, Ah600, HSK600, HXL840, SHK840, SHK845 and SHK850. (Gold Key)	













## IGNITION SETS - POINTS and CONDENSERS continued

Part#	OEM#	Application	
<b>450-007</b>	B&S# 294628	<b>Briggs Ignition Set</b> - Fits 2 thru 8 Hp engines. Models 60100 thru 195400	
<b>450-015</b>	B&S# 29667 B&S# 29861	<b>Briggs Ignition Set</b> - Fits models I, N, U, W, 5, 6, 6F, 6R, 6S, 8 and 140000.	
<b>450-114</b>	B&S# 29667 Wico# X15022	<b>Briggs Breaker Points</b> - Fits models I, N, U, W, 5, 6, 6F, 6R, 6S, 8 and 140000.	
(While Quantities Last)			
<b>450-148</b>	B&S# 298185	<b>Briggs Breaker Points</b> - Fits 8 thru 16 Hp cast- iron engines Models 19D, 23D, 193400, 200400, 233400, 243400, 300400, 301430, 302430, 320420, 325430 and 326430.	
<b>450-155</b>	B&S# 391284	<b>Briggs Breaker Points</b> - Fits 10 and 11 Hp engines. Models 220000 thru 222000 and 252400 thru 253400	
(While Quantities Last)			
<b>455-006</b>	B&S# 29861 Wico# X15023	<b>Briggs Condenser</b> - Fits 10 and 11 Hp engines. Models I, N, U, W, 5, 6, 6F, 6R, 6S, 8, 146000 thru 171000, 200400 thru 222400, 251400 thru 253400. (Use with our 450-114 breaker points)	
(While Quantities Last)			
<b>455-014</b>	B&S# 291369 Wico# X15032	<b>Briggs Condenser</b> - Fits models 9, 14, 19, 23, 23A and 191400 thru 231400. (Use with our 450-122 breaker points)	
(While Quantities Last)			
<b>455-022</b>	B&S# 298060	<b>Briggs Condenser</b> - Fits 8 thru 16 Hp cast-iron engines. Models 19D, 23D, 193400, 200400, 233400, 243400, 300400, 301430, 302430, 320420, 325430 and 326430. (Use with our 450-148 breaker points)	
<b>450-130</b>	B&S# 65704	<b>Briggs Point Plungers</b> - Fits 2 thru 11 Hp vertical and horizontal engines. (Made of a fibre material).	
(Sold in multiples of 10)			
<b>450-239</b>	Clinton# 135-7-500 Jacobsen# 107811 John Deere# AM30947 Lombard# 7-1120, McCulloch# 80433 / 88806. Phelon# FG1835B / FG03560 / 02197-00B, 06230, Remington# 60623	<b>Clinton Breaker Points</b> - Fits many makes	
<b>455-162</b>	Clinton# 135-024-000 John Deere# AM30949 Phelon# FG1316 / FG06225 / 071130	<b>Clinton Condenser</b> - Fits many makes	
<b>455-048</b>	Fairbanks# AXMR-2433 Gravelly# 13909	<b>Fairbanks Morse condenser.</b>	
(While Quantities Last)			











**IGNITION SETS - POINTS and CONDENSERS continued**

<b>Part#</b>	<b>OEM#</b>	<b>Application</b>	
<b>450-171</b>	Kohler# 266240 Gravely# 12979 Wisconsin# W2437 Wisconsin# A-2437A / 10412437	<b>Kohler Breaker Points</b> - Fits 4 thru 16 Hp engines with magneto ignition.	 <i>(While Quantities Last)</i>
<b>450-288</b>	Kohler# 240611 Gravely# 13996 (points) Gravely# 34907 (only) Wisconsin# X6942 / X5996	<b>Kohler Breaker Points</b>	 <i>(While Quantities Last)</i>
<b>450-403</b>	Kohler# 47-150-01 Kohler# 47-150-03 Kohler# 220980 Gravely# 15435	<b>Kohler Breaker Points</b> - Models K91 thru K361. For 6 thru 20 Hp engines with battery ignition. (For breaker points less bracket, order our 450-029 below).	 Includes Bracket >
<b>450-029</b>	Kohler# 47-150-03 Wico# WX13260 Wico# WX15241 JD# AM31026	<b>Kohler Breaker Points</b> - Fits models K91, 141, 161, 181, 241, 301, 321, 341, 361, Kt17, 482, 19, 532, 21 and 582 series.	
<b>455-147</b>	Kohler# 230722 Gravely# 11824	<b>Kohler Condenser</b> - Fits models K91 thru K582 with battery ignition. (Use our breaker points 450-029 or 450-403).	
<b>455-113</b>	Kohler# 232526 Tecumseh# 29177 Phelon# FG-4082 Phelon# FG-06867	<b>Kohler Condenser</b> - Fits models K141 thru K341 with magneto ignition.	 <i>(While Quantities Last)</i>
<b>455-170</b>	Kohler# 235786 Kohler# 47-147-01 Gravely# 10845 Phelon# FG-07533	<b>Kohler Condenser</b> - Fits models K141 thru K341 with magneto ignition.	 <i>(While Quantities Last)</i>
<b>450-197</b>	Lawn Boy# 677254 Wico# X15046	<b>Lawn Boy Breaker Points</b> - Fits C and D series engines.	
<b>450-023</b>	Tecumseh# 30547A Tecumseh# 30548B	<b>Tecumseh Ignition Set</b> - Fits 3 thru 10 Hp engines. Models H, HH40 thru 70, HM70 thru 100, HS, LAV, TNT, V, VH and VM series.	
<b>450-239</b>	Tecumseh# 27948 Tecumseh# 30547A Lombard# 7-1120 McCulloch# 80433 / 88806 Remington# 60623 Phelon# FG1835B / FG03560 / 02197-00B	<b>Tecumseh Breaker Points</b> - Fits 3 thru 10 Hp engines. Models H, HH40 thru 70, HM70 thru 100, HS, LAV, TNT, V, VH and VM series. (Use with our 455-162 condenser)	
<b>450-270</b>	Tecumseh# 27526 Tecumseh# 29625 Jacobsen# 107402 Poulan# 3943 / F366, Wico# X11030 / X11211	<b>Tecumseh Breaker Points</b>	









## IGNITION SETS - POINTS and CONDENSERS continued

Part#	OEM#	Application	
<b>450-213</b>	Tecumseh# 610275 Clinton# 135-128-500 Jacobsen# 104353 McCulloch# 75101A / 1340135 Phelon# FG00626 / 04205-00-D / Wico# X15011	<b>Tecumseh Breaker Points</b>  (While Quantities Last)	
<b>455-162</b>	Tecumseh# 30548B Clinton# 135-24-000 Phelon# FG-1316 Phelon# FG-06225	<b>Tecumseh Condenser</b> - Fits 3 thru 10 Hp engines. For models H, HH40 thru 70, HM70 thru 100, HS, 638, 650, 670, LAV, TNT, TVS520 thru 600, V, VH and VM series. (Use with our 450-239 breaker points)	
<b>455-204</b>	Tecumseh# 29164 Tecumseh# 27527 Jacobsen# 314457 Poulan# F356 / Wico# X11000	<b>Tecumseh Condenser</b>  (While Quantities Last)	
<b>455-105</b>	Tecumseh# 610467 Jacobsen# 315804 Phelon# FG-2642B	<b>Tecumseh Condenser</b>  (While Quantities Last)	
<b>455-121</b>	Tecumseh# 610588 Lombard# 7-1153 Phelon# FG-4016B Wright# 603502	<b>Tecumseh Condenser</b> - Fits models 1401J, 1577, 15060, 1534D, 1581A, 1574B and 1576B.  (While Quantities Last)	
<b>455-089</b>	Tecumseh# 610331 Clinton# 135-241-500 Phelon# FG-1355	<b>Tecumseh Condenser</b>  (While Quantities Last)	
<b>450-296</b>	Wisconsin# YQ-314A Wico# 14508B	<b>Wisconsin Breaker Points</b> - Fits models S8.  (While Quantities Last)	
<b>450-320</b>	Wisconsin# YQ-11	<b>Wisconsin Breaker Points</b>  (While Quantities Last)	
<b>450-171</b>	Wisconsin# W2437 Wisconsin# A-2437A Wisconsin# 10412437 Gravely# 12979, Kohler# 266240	<b>Wisconsin Breaker Points</b>  (While Quantities Last)	
<b>450-163</b>	Wisconsin# 31B-2437A	<b>Wisconsin Breaker Points</b>  (While Quantities Last)	
<b>455-501</b>	Wisconsin# YQ-11 Wico# X12944 Wico# Wx15254 / FWM-2308	<b>Wisconsin Condenser</b> - Fits model S-7  (While Quantities Last)	
<b>455-519</b>	Wisconsin# YD-315 Wico# X14590 Wico# WX15250	<b>Wisconsin Condenser</b> - Fits models S8 and TR10.  (While Quantities Last)	

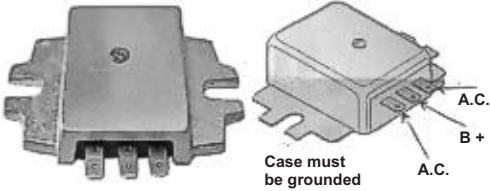
**REGULATORS**

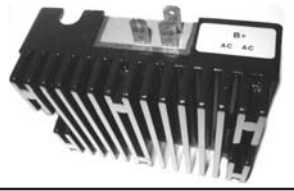

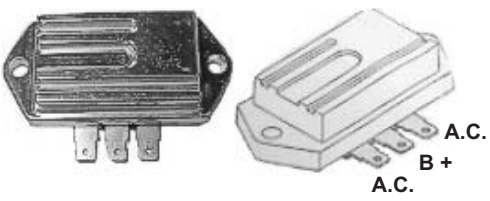
<b>Part#</b>	<b>OEM#</b>	<b>Application</b>	
<b>435-040</b>	B&S# 295924 Delco# 1118988 Jacobsen# 107927 John Deere# Am30078, Tecumseh# 32089	<b>Briggs Voltage Regulator</b> - For starter generators. Fits models 140201, 140202, 140232, 141202, 141231, 141251, 141252, 243431 and 243432.	
<b>435-042</b>	B&S# 691185 B&S# 394890 B&S# 393374	<b>Briggs Voltage Regulator</b> - For 18 - 20 Hp engines with 10, 13, 14 and 16 AMP charging systems. Fits models 192400, 196400, 226400, 28M700, 280700 and 351700.	
<b>435-046</b>	B&S# 397809	<b>Briggs Voltage Regulator</b> - For 8 amp quad circuit charging system. (Used on 422700 series engines).	
<b>435-047</b>	B&S# 691188 B&S# 491546	<b>Briggs Voltage Regulator</b> - For 5 & 9 amp charging systems. Fits models 256400, 280700, 28B700, 28M700 thru 28Q700, 351400, 351447, 351700, 351777 and 42A700 series engines. (1) yellow & (1) red lead	
<b>435-048</b>	B&S# 493219	<b>Briggs Voltage Regulator</b> - For 16 amp dual output charging systems. (With no charge indicator light), 8 thru 20 Hp engines. (Used on 303700 series engines).	
<b>435-010</b>	Grasshopper# 185530 Kubota# 15531-64603	<b>Grasshopper and Kubota Voltage Regulator</b> Fits Grasshopper models 1822D, 718D, 721D & 721G. Used on lawn & garden, compact tractors and small industrial equipment with permanent magnet alternators with a "no charge" indicator light.	
<b>435-009</b>	Honda# 31600-890-951	<b>Honda Voltage Regulator</b> - For Honda Lawn Tractors.	
<b>435-005</b>	John Deere# AM101406	<b>John Deere Voltage Regulator</b> - Used on garden tractor models 322, 330, 332 and commercial mower model F915, also used on compact tractor models 670, 770, 870, 970 and 1070.	
<b>435-006</b>	John Deere# M802471	<b>John Deere Voltage Regulator</b> - Used on models 650 and 750 - compact tractors.	
<b>435-013</b>	Kawasaki# 21066-2056 John Deere# M70121	<b>Kawasaki &amp; John Deere Voltage Regulator</b> Fits Kawasaki models FB460, FC400, FC420 & FC540. For 13, 15 and 17 amp charging system up to 18 Hp engines. Also fits John Deere models 130, 160, 165, 170, 172, 175, 176, 180, 185, 186, 240, 242, 245, 265, 285, 320, 325, 345, F510, F525, F710 and F725. Fits ATM models 600, 622 and 626. Fits Gator 4X2 & 6X4 models with 15 amp charging systems.	

**REGULATORS continued**

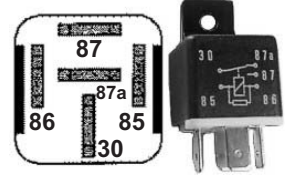

Part#	OEM#	Application	
<b>435-004</b>	Kawasaki# 21066-2070 John Deere# M97348	<b>Kawasaki &amp; John Deere Voltage Regulator</b> For 20 and 22 Hp water cooled V-twins. Also fits the following John Deere applications: models 425, 445 and F911, Gator 6X4 models with 20 amp charging systems.	
<b>435-014</b>	Kawasaki# 21066-2071 John Deere# AM109462	<b>Kawasaki Voltage Regulator - Fits on commercial walk behind mowers.</b>	
<b>435-085</b>	Kohler# 41-403-08 John Deere# AM102596 Tecumseh# 610749	<b>Kohler Voltage Regulator</b> Fits K series engines. 8 thru 12 Hp single cylinder engines. For 10 amp charging systems.	
<b>435-081</b>	Kohler# 25-755-03 Kohler# 41-403-01 Kohler# 41-403-04 Kohler# 41-403-05 Kohler# 41-403-09	<b>Kohler Voltage Regulator - Fits models KT-17 thru 19, M8 thru MV20 and quiet series.</b> For 15 amp charging systems.	
<b>435-084</b> <b>NEW</b>	Kohler# 41-403-06	<b>Kohler Voltage Regulator - For 8 thru 24 Hp engines with 15 amp alternators. Fits models K181, K241, K301, K321, K482, K532 and K582. "L" pattern with (2) terminals. Uses system "S" series K181 thru K582, 10 - 16 Hp single cylinder. Also fits John Deere. Terminals: (1) B+ at top with (2) AC terminals side by side. Same "L" pattern as our 435-083 regulator below</b>	
<b>435-083</b>	Kohler# 41-403-06 Kohler# 237335 John Deere# AM37200	<b>Kohler Voltage Regulator</b> Fits 8 thru 24 Hp engines Models K181 thru K582, 15 amp style, 12 V neg. Terminals 2 over, 1 under	
<b>435-019</b>	Kohler# 12-403-01	<b>Kohler Voltage Regulator</b> Used on commercial walk behind mowers with Kohler engine with electric P.T.O. clutch, rope starter and no battery. Used on CV11, CV12.5, CV13, CV14, CV15 & CV18 model engines.	
<b>435-011</b>	Onan# 191-1748 Onan# 191-2106 Onan# 191-2277	<b>Onan Voltage Regulator</b> Used on engines 16 thru 20 Hp Also used on John Deere models 318-420 with Onan engines.	

**Please visit our web site for more information and pictures @ [www.bantasaw.com](http://www.bantasaw.com)**

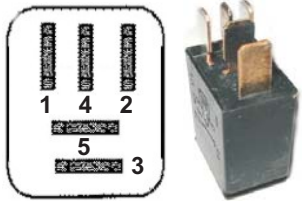
**RELAYS**

Part#	OEM#	Application	
<b>435-369</b>	AYP# 109748X Husqvarna# 532 10 97-48	<b>Relay Switch</b> - Found on many Riders made by AYP. ie: Poulan, Jonsereds and Husqvarna etc. Also fits Great Dane, John Deere, Encore and Grasshopper lawn & garden equipment.	
<b>435-370</b> <b>NEW</b>	AYP / Husqvarna	<b>Relay Switch</b> - Fits Husqvarna ZTR and Country Clipper zero turn radius models. Helga ID# 93180 01	
<b>435-371</b> <b>NEW</b>	AYP / Husqvarna	<b>Relay Switch</b> - Fits Husqvarna ZTR and John Deere Z TRAK models. Bosch# 0332 209-150	
<b>435-550</b> <b>NEW</b>	MTD# 925-1648 MTD# 725-1648	<b>Relay Switch</b> - Fits Autodrive riding mowers and snowblowers. - 12 Volt - 20 amp	







**SOLENOIDS - Universal Application** (These "2" solenoids replace over "50" solenoids).

<p><b>435-071</b></p> <p>Replaces Ariens# 03057700 Bolens# 1751569 Murray# 424285 Murray# 924285 Murray# 21261 Murray# 24285 MTD# 725-0771 MTD# 725-1426 MTD# 725-0530 MTD# 925-1426 MTD# 925-0771 Nama# 53716 Noma# 52323 Snapper# 1-8817 Toro# 111674 Troy Bilt# 1751569</p>	<p><b>Universal "3" Pole (chassis ground)</b></p> <p>Terminal posts will accommodate both 5/16" and 1/4" terminal connectors. Mounting bracket will accommodate both chassis and wall mount configurations.</p>		<p><b>435-072</b></p> <p>Replaces Ariens# 03551000 AYP# 109081X AYP# 109946 AYP# 146154 Bolens# 1752137 Bolens# 1753539 Case# C-266525 Case# C33025 Exmark# 1-513075 Gilson# 212655 Grasshopper# 184251 Gravelly# 045071 Lawn Boy# 740207 Simplicity# 170051 16771993 / 16852980 1700751/ 1686981 Snapper# 1-8604 Toro# 47-1910 Toro# 110116 1101162 / 110167, Troy Bilt# 1752137 / 1753539 / 1752137P</p>	<p><b>Universal "4" Pole (terminal ground)</b></p> <p>Terminal posts will accommodate both 5/16" and 1/4" terminal connectors. Mounting bracket will accommodate both chassis and wall mount configurations.</p>	
--	---	---	--	--	---



**SOLENOIDS - O.E.M. Applications**

<p><b>435-016</b></p> <p>Universal Type Cushman# 889673 Dixie Chopper# 20253</p>	<p><b>Universal Solenoid</b> - Many applications. Fits 50" and 60" cut Dixie Chopper with 20 &amp; 24 Hp Kohler engines. - 4 pole style - 12 volt - 5/16"-24 studs - Grounded through base</p>	
--	--	---







**SOLENOIDS continued**

Part#	OEM#	Application	
<b>435-008</b>	Gravely# 7277 Snapper# 1-9544	<b>Solenoid</b> - Many applications - 3 pole style - 12 volt - 1/4"-20 studs - Grounded through base	
<b>435-099</b>	AYP# 146154 / 24285 AYP# 3367R / 44429 AYP# 138406X / 2008J AYP# 2161 / 677A880 Ariens# 35510 Bolens# 1752137 Bolens# 1753539 Case# C-26525 / C-33025, Gilson# 212655, Grasshopper# 184251, Gravely# 45071, Lawn Boy# 740207, Simplicity# 1700751 / 1685290, Snapper# 1-8604, Stiga# 1134-2946-02, Toro/Wheel# 28-4210, Toro/Wheel# 47-1910 / 110162	<b>Solenoid</b> - Grounded through pole not base - 4 pole style - 12 volt - 1/4"-20 studs - Includes new spade converters	
<b>435-032</b>	Ariens# 35770 Ariens# 35832 Bolens# 1751569 Bunton# PI4007 Encore# 363027 MTD# 725-0530 Noma# 53716 / 52323, Scag# 48106, Simplicity# 1671994, Snapper# 1-8817, Stiga# 1134-2946-01, Toro/Wheel# 11674	<b>Solenoid</b> - Internal ground with screw terminal - 3 pole style - 12 volt - 5/16"-24 studs - Includes new spade converters	
<b>435-065</b>	AYP# 110832X MTD# 725-1426 MTD# 725-0771 Murray# 21261 Snapper# 1-8817	<b>Solenoid</b> - 90 degree mount - Grounded through base - 3 pole style - 12 volt - 1/4"-20 studs	
<b>435-097</b>	AYP# 109081X AYP# 109946X Murray# 24285 Snapper# 1-8817 Toro/Wheel# 111674	<b>Solenoid</b> - Grounded through base - 3 pole style - 12 volt - 1/4"-20 studs	
<b>NEW</b> <b>435-077</b>	John Deere# AM132990 John Deere# AM133094 John Deere# AM130365	<b>Solenoid</b> - 90 degree mount - 4 pole style - 12 volt - 5/16"-24 studs - 2 spade terminals	





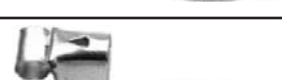

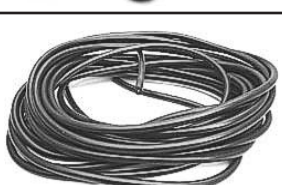



**SPARK PLUG ACCESSORIES**

<b>135-107</b>	Universal	<b>Spark Plug Boot</b> - Used on Lawnmowers, ATV's and Mini-Bikes. Boot has a threaded screw for high tension lead. For 7mm spark plug wire.	
<b>135-133</b>	Stihl# 1108-405-1000	<b>Spark Plug Boot</b> - Found on Stihl Quik cut saws and old 08 / 08S chain saws. Using the smaller 5mm spark plug wire.	

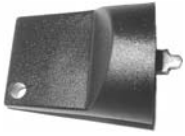
**SPARK PLUG ACCESSORIES continued** Sold in multiples of 10

Part#	OEM#	Application	
<b>135-053</b>	Homelite# A55373-A	<b>Spark Plug Boot</b> - For many Chain Saws & Trimmers > 5mm spark plug wire.	
<b>135-095</b>	Lawn Boy# 510231 Lawn Boy# 580339 / 684698	<b>Spark Plug Boot</b> - For Lawn and Garden equipment. > standard 7mm spark plug wire.	
<b>135-046</b>	Tecumseh# 610118	<b>Spark Plug Boot</b> - Found on Lawn and Garden equipment. Using the standard 7mm spark plug wire.	
<b>NOTE: Above are - (Sold in multiples of 10)</b>			
<b>NEW</b> <b>135-204</b>	Husqvarna# 501-485-402	<b>Spark Plug Boot</b> - 90 degree for chain saw models 340, 345, 346, 350 and 351. __mm spark plug wire.	
<b>NEW</b> <b>135-213</b>	Husqvarna# 501 48 54-02	<b>Spark Plug Boot</b> - 45 degree for trimmer models 232, 235, 322 and 325. 5mm spark plug wire.	
<b>NEW</b> <b>135-065</b>	Honda# 30700-ZE1-013 Code# 3526837	<b>Spark Plug Boot</b> - Fits models GX120, GX140, GX160, GX200, GX240, GX270, GX340 and GX390.	
<b>NEW</b> <b>135-516</b>	Kawasaki# 21130-0256 Kawasaki# 20010-72221 Mitsubishi# Tr64961 Shindaiwa# 22102-72220	<b>Spark Plug Boot</b> - Fits Kawasaki models TD26, TDd40, TD43 and TD48. Fits Shindaiwa models T25, T27 and C35. Fits Mitsubishi models TL26, TL33, TL43 and T200.	
<b>135-119</b>	NGK# LB05EP	<b>Spark Plug Boot</b> - 90 degree - Made by NGK Comes with wire end, water tight boot and has a built-in resistor of 5000 OHMS.	
<b>135-121</b>	NGK# LB05EP NGK# VB05F NGK# VBOF 8032 45	<b>Spark Plug Boot</b> - 45 degree - Made by NGK Fits overhead valve engines.	
<b>135-012</b>	B&S# 221798	<b>Spark Plug Clip</b> - Universal application. Used in our 135-046 spark plug boots.	
<b>135-015</b>	Universal	<b>Spark Plug Clip</b> - Universal application. Used in our 135-053 & 135-095 spark plug boots.	
<b>135-017</b>	B&S# 493880 Above are (Sold in multiples of 10)	<b>Terminal Spark Plug</b> - Universal application. Fits 7mm spark plug wire, positive lock.	
<b>135-061</b>	Universal	<b>Spark Plug Wire</b> - 5mm, Quality black hypolon outer, copper wire inner (Priced and Sold in 10 meter rolls) i.e.: 30 plus feet	
<b>135-004</b>	Universal	<b>Spark Plug Wire</b> - 7mm, Quality black hypolon outer, copper wire inner (Priced and Sold in 10 meter rolls) i.e.: 30 plus feet	
<b>135-020</b>	Universal	<b>Shorting Clip</b> - Clamp on style, Length: 2-1/2" Fits all 14mm spark plugs with 13/16" nut	
<b>135-038</b>	Universal Above are (Sold in multiples of 10)	<b>Shorting Clip</b> - Bolt on style, Length: 3" Univ. application, pointed to penetrate plug boot	

**SWITCHES and ACCESSORIES - UNIVERSAL**

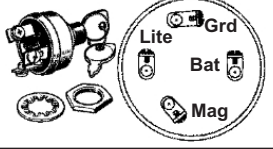
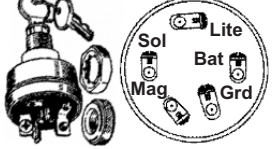
Part#	OEM#	Application	
430-017	Universal	<b>Kill Switch</b> - Used as an on / off switch Found on many Chain saws and Trimmers using a single wire, self grounding type switch.	
430-066	Universal	<b>Deluxe Kill Switch</b> - Used as an on / off switch Found on many Go-carts and ATV's. Comes with a 48" lead wire and two metal clamps with screw.	
430-070	Universal	<b>Kill Button</b> - Comes complete with 42" wire lead. Fits 7/8 - 1" tube handles. Used on Lawn and Garden equip. as well as Mini-bikes, Go-carts etc.	
430-009	Indak Key	<b>Starter Key</b> - Fits all Lawnmowers with Indak switches. Found on MTD, Murray, Noma, Toro/Wheel Horse and other types of equipment.	 Sold in multiples of 10
430-488 <small>(Sold individually)</small>	MTD# 725-0128 Troy Bilt# 9243	<b>MTD and Troy Bilt Starter Key</b> - Found on MTD, Toro / Wheel Horse, John Deere & many others. Also fits Troy Bilt electric start models.	
430-493 <b>NEW</b> <small>(Sold individually)</small>	MTD# 725-1341B	<b>Molded Ignition Key for MTD</b> - Has ergonomic slip resistant comfort grip.	
430-223	Universal	<b>Universal Wiring Harness</b> - Works with our 430-538, 430-013, 430-512 and most other 5 terminal type switches. Length: 18" with (5) colour coded wires. Wires are protected by a plastic cover.	
430-206	Universal	<b>Universal Switch Connector</b> - Works with our 430-538, 430-013, 430-512 and most other 5 terminal type switches.	 Sold in multiples of 10
430-207 <small>(Sold in multiples of 10)</small>	Universal	<b>Universal Switch Terminals</b> - Slide on terminal ends. Works with our 430-207 connector.	
425-272	Universal	<b>In Line Fuse Holder</b> - 16 gauge wire, molded plastic fuse holder. Comes complete with 10" of wire & 20 amp fuse.	
425-306	Universal	<b>In Line Fuse Holder</b> - For ATC / ATO style fuses up to 30 amp, 10 AWG wire.	
430-033	Universal	<b>Starter Switch</b> - 3 position, 4 terminal 1st - magneto ground 2nd - battery and light 3rd - off Stem diameter: 3/4"	
430-041	Universal	<b>Starter Switch</b> - 4 position, 5 terminal 1st - magneto ground 2nd - battery and light 3rd - battery and solenoid 4th - off Stem diameter: 3/4"	

**SWITCHES - IGNITION**

**Part# Application**  
**430-029** 5/8" mounting stem, on / off switch  
 (2) position, (2) terminal  
 Battery type switch found on many single  
 stage snowblowers.

**O.E.M. Applications**

Ariens# 11134 / 24656  
 Ariens# 524069 / 624097  
 Ariens# 52406900 / 02456500  
 AYP# 135944  
 Cub Cadet# 725-3232  
 Exmark# 403121  
 Ferris# 1521842  
 Grasshopper# 184-082  
 Great Dane# D18090  
 Homelite# JA13064-1  
 Lawn Boy# 700171 / 740015  
 Murray# 56419  
 Noma# 49907 / 56992  
 Scag# 48609  
 Simplicity# 1664804  
 Snapper# 1-7817  
 Troy Bilt# 175-8145



**430-249** 5/8" mounting stem, battery type switch  
 (3) position, (5) terminal

**O.E.M. Applications**

Ariens# 31152  
 AYP# 2683 / 2683R  
 Gravely# 19223 / 019223  
 Jacobsen# 129846  
 John Deere# AM103286  
 John Deere# AM32686  
 John Deere# AM32318  
 Toro# 12-8140  
 Troy Bilt# 12-840

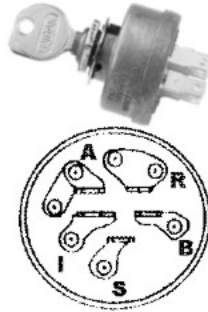

**430-541** 5/8" mounting stem, magneto type switch  
 (4) position, (5) terminal

**O.E.M. Applications**

AYP# 14615  
 AYP# 73232

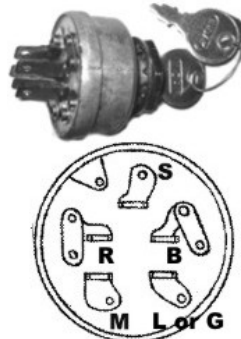

Use our "Universal wiring harness"  
**Part# 430-223**  
 on all 5 spade ignition switches.  
 See pg 24-16 "Switches & Accessories -  
 Universal"

**SWITCHES - IGNITION**

**Part# Application**  
**430-542** 5/8" mounting stem  
 (3) position, (4) spade terminals plus  
 (2) heavy screw in terminals - "BAT" & "SOL".  
 Also replaces the following switches: 74R, 2210R,  
 5797H, 7486H, 9541H, 21037, 71577, 72841 and 511404

**O.E.M. Applications**

AYP# 365401R

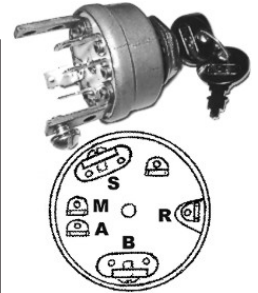

**430-543** 5/8" mounting stem, magneto type switch  
 (3) position, (5) terminal

**O.E.M. Applications**

AYP# 158913  
 Exmark# 543070

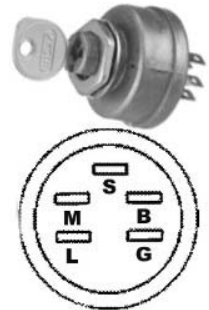

**430-538** 5/8" mounting stem, magneto type switch  
 (3) position, (5) terminal

**O.E.M. Applications**

AYP# 3612R / 4406R / 365402  
 Bobcat# 480032B  
 Bunton# PAL0903  
 Cub Cadet# 725-3026  
 Dixon# 4197  
 Economy# 03-2018  
 Gilson# 36457  
 Honda# 35100-772-003  
 John Deere# AM102551  
 Lawn Boy# 741308  
 MTD# 725-0267 / 925-0267  
 Murray# 21064 / 21064PA  
 Noma# 44745 / 300295  
 Noma# 421064 / STD365402  
 Scag# 48017  
 Simplicity# 178280  
 Toro# 23-0660

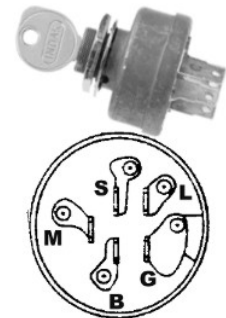

**430-538**  
**This is our most popular**  
**"Ignition Switch"**

**SWITCHES - IGNITION**

Part#	Application
<b>430-110</b>	(3) position, (6) terminal Fits models 235432, 235437, 245432, 245437, 28N707, 28N777, 28Q777, 350422.
<b>O.E.M. Applications</b>	
Briggs & Stratton# 493625 Briggs & Stratton# 692318 Scag# 48798	

<b>430-013</b>	5/8" mounting stem, magneto type switch (4) position, (5) terminal
<b>O.E.M. Applications</b>	
Gravely# 18272 Gravely# 018272 Murray# 91846 Noma# 300687 Noma# 305720	

<b>430-245</b>	9/16" mounting stem, magneto type switch (3) position, (5) terminal Fits 110, 112 and 140 tractors
<b>O.E.M. Applications</b>	
John Deere# AM31995 John Deere# AM102544	

**Waterproof Kit for INDAK Switches**

<b>430-000</b>	<b>Need pitures Rotary#'s 31-10792 and 31-10791</b>
Two piece kit: > (1) plastic nut > (1) rubber bezel	

**SWITCHES - IGNITION**

Part#	Application
<b>430-250</b>	13/16" mounting stem, magneto type switch (3) position, (6) terminal Fits models F910, F930 front mounts; 130, 165, 170, 175, 180, 185, F912, F915, F925, RX73, RX75, RX95, SX75 and SX95.
<b>O.E.M. Applications</b>	
John Deere# AM101561	

<b>430-251</b>	9/16" mounting stem, magneto type switch (3) position, (6) terminal Fits S910 and S930 front mount, 108, 111, 112, 116 lawn tractors, 316, 318, 420 garden tractors, GS25, GS30, GS45, GS75, HD45 & HD75. Also found on 300 & some 200 series.
<b>O.E.M. Applications</b>	
John Deere# AM38227 Kohler# 25-099-03	

<b>430-128</b>	9/16" mounting stem, magneto type switch (3) position, (6) terminal Fits models CH11, CH12.5, CH14, CH18, CH20, CH22, CH25, CV12.5, M8, M10, M12, M16, M18, M20, TH16 and TH18.
<b>O.E.M. Applications</b>	
Kohler# 25-099-04 Kohler# 25-099-02 Toro# 103991 Toro# 111215	

**SWITCHES - IGNITION**

**Part#**      **Application**  
**430-553**    5/8" mounting stem  
 (3) position, (6) terminal  
 Fits all MTD lawn and garden tractors with  
 Briggs & Stratton OHV Vanguard engines.

**O.E.M. Applications**

MTD# 725-1396  
 MTD# 925-1396

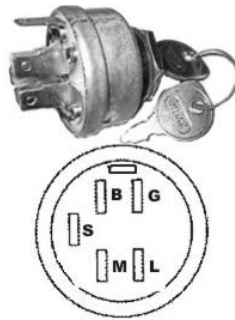

**430-488 Starter Key** - Fits most MTD riders, also  
 found on some Troy Bilt equipment.

**O.E.M. Applications**

MTD# 725-0128  
 Troy Bilt# 9243



**430-655**    Snap in mounted  
 (3) position, (5) terminal  
 (Uses our 430-667 key)

**O.E.M. Applications**

John Deere# AM122881

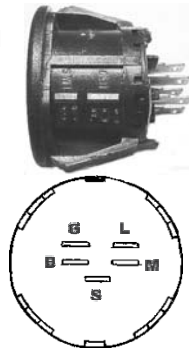

**430-667 Ignition Switch Keys** - fit our 430-658,  
 430-659, 430-660, 430-661, 430-662,  
 430-663, 430-664, 430-665 and 430-666  
 ignition switches.



**430-009 Indak Ignition Switch Keys** - fit most  
 INDAK switches.  
 (Sold in multiples of 10)



**Sold in  
 multiples  
 of 10**

**430-009**

**Is our most popular ignition key**

**SWITCHES - IGNITION**

**Part#**      **Application**  
**430-161**    5/8" mounting stem, magneto type switch  
 (4) position, (6) terminal  
 Fits front engine riders, 1992 and newer

**O.E.M. Applications**

Murray# 92377

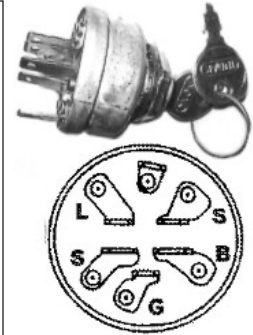

**430-156**    5/8" mounting stem  
 (4) position, (7) terminal  
 For engines equipped with fuel shut off  
 solenoid - built since 1994.  
 Fits model 461004X92A

**O.E.M. Applications**

Murray# 92556  
 MTD# 725-1717  
 AYP# 140301

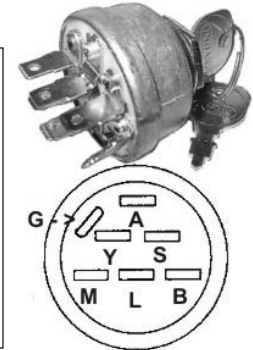

**430-654**    Thread mounted  
 (3) position, (5) terminal  
 (Uses our 430-668 nut & 430-667 key)

**O.E.M. Applications**



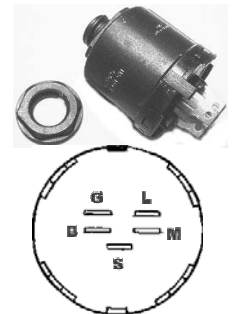



AYP# 140399  
 AYP# 144921  
 AYP# 154855  
 AYP# 163088  
 AYP# 178744  
 Murray# 327355  
 Simplicity# 1718306  
 Simplicity# 1713845  
 Simplicity# 1686734





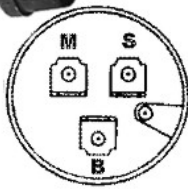

**430-668**    Plastic Nut - Fits our  
 430-654 ignition switch.  
 (Sold in multiples of 10)



**SWITCHES - IGNITION**

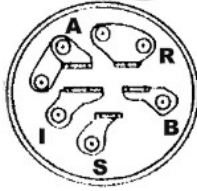

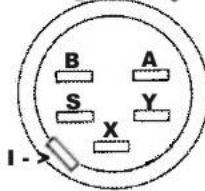

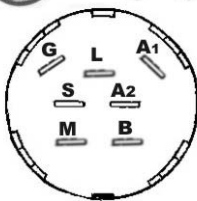
Part#	Application
<b>430-015</b>	Snap in mounted (4) position, (7) terminal Fits Husky models YTH1542XP / 1542TPG / 1848XP, LTH1342 / 1342A & YTHP1542. John Deere models L100, 105, 107, 110, 120, 130, G110, LY18 and some Scotts / Sabre models. Fit MTD auto step thru frame tractors 1999 and newer.
<b>O.E.M. Applications</b>	
AYP# 163968 / 175442 / 175566 Husqvarna# 532 17 55-66 John Deere# GY20074 Murray# 94762 MTD# 725-1741 / 925-1741	
	
<b>430-504</b>	5/8" mounting stem, magneto type switch (2) position, (1) terminal Single screw terminal. found on riders.
<b>O.E.M. Applications</b>	
Snapper# 1-1853	
	
<b>430-520</b>	5/8" mounting stem, magneto type switch (3) position, (3) terminal Fits all riders 1973 thru 1987 with screw terminals.
<b>O.E.M. Applications</b>	
Snapper# 1-1155	
	
	
<b>430-144</b>	5/8" mounting stem, magneto type switch (3) position, (3) terminal Fits rear engine riders. Series 6 thru 11, 1988 to present
<b>O.E.M. Applications</b>	
Snapper# 1-8816	
	
	
<b>430-165</b>	5/8" mounting stem, push button switch (2) position, (2) terminal
<b>O.E.M. Applications</b>	
Snapper# 1-2623	
	

**SWITCHES - IGNITION**





Part#	Application
<b>430-512</b>	5/8" mounting stem, battery type switch (3) position, (5) terminal
<b>O.E.M. Applications</b>	
Toro# 103990 Kohler# 48-099-01	
	
	
<b>430-954</b>	9/16" mounting stem, battery type switch (3) position, (6) terminal Fits Toro Groundsmaster 3, 52, 62, 72, 172, 322, 325 327, 400, 500, RM223D, 450D, 335D, 5100D.
<b>NEW</b>	
<b>O.E.M. Applications</b>	
Toro# 27-2360	
	
	
<b>430-523</b>	(2) position, (2) terminal For models S200 and S620 snowblowers. Also fits 32", 36", 37", 44" and 52" mid sized commercial mowers with pull start.
<b>O.E.M. Applications</b>	
Toro# 29-5560 Toro# 40-5940	
	
<b>430-710</b>	( ) position, (7) terminal Fits models Stiga Park 2000 and Stiga Villa 2001
<b>NEW</b>	
<b>O.E.M. Applications</b>	
Stiga# 1134-4093-01	
	
	

**SWITCHES - Mullti Application start on the next page listed in alphabetical order by manufacturers name.**

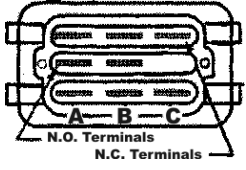

**SWITCHES - Multi Application**

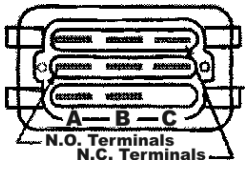
Part#	Application
<b>430-017</b>	<b>Universal Kill Switch</b> - On / off switch found on many chain saws and trimmers. Using a single wire, self grounding type switch.
<b>O.E.M. Applications</b>	
Green Machine# 201030 Homelite# 63938 Homelite# 93653 John Deere# PT1008 Toro# 29-7660 Weedeater# 90824 Weedeater# 534-193001	
<b>430-066</b>	<b>Universal Deluxe Kill Switch</b> - On / Off switch found on Go-carts, ATV's etc. Comes complete with a 48" lead wire and (2) metal clamps with screws.
<b>O.E.M. Applications</b>	
Universal	
<b>430-070</b>	<b>Kill Button</b> - Comes complete with 42" lead wire, fits 7/8" - 1" tube handles. Used on lawn & garden equipment as well as mini-bikes, Go-carts etc.
<b>O.E.M. Applications</b>	
Universal	
<b>425-272</b>	<b>Universal In-Line Fuse Holder</b> - 16 gauge wire, molded plastic fuse holder. Comes complete with 10" of wire and 20 amp fuse.
<b>O.E.M. Applications</b>	
Universal	
<b>425-306</b>	<b>Universal In-Line Fuse Holder</b> - For ATC / ATO style fuses, up to 30 amp, 10 AWG wire.
<b>O.E.M. Applications</b>	
Universal	



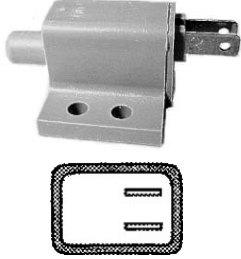
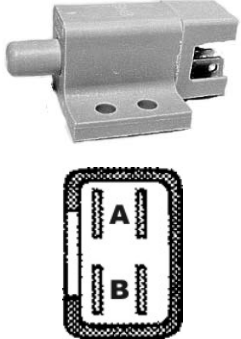
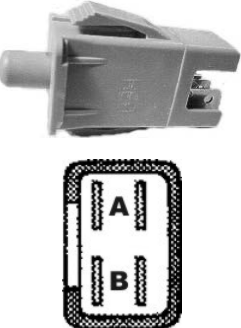

**SWITCHES - Multi Application**

Part#	Application
<b>430-657</b>	<b>PTO Switch</b> - Middle terminal blank. Push - pull / snap mount
<b>O.E.M. Applications</b>	
Ariens# 5221 / 522100 Ariens# 1545600 Exmark# 633673 John Deere# AM118802 John Deere# AM119139 Kubota# K1211-62230 Kubota# K1211-62231 MTD# 725-3233 MTD# 725-1716 / 925-1716 MTD# 725-1752 / 925-1752 Scag# 481635 Snapper# 2-8542 Toro# 95-4108 / 95-7489 Toro# 93-9998 / 93-9999	 
<b>430-777</b>	<b>PTO Switch Retaining Ring</b> - Used with our 430-656 and 430-657. (Sold in multiples of 5)
<b>O.E.M. Applications</b>	
AYP# 140405	
<b>430-656</b>	<b>PTO Switch</b> - Corner terminal blank. Push - pull / snap mount
<b>O.E.M. Applications</b>	
AYP# 140404 / 146283 AYP# 154959 / 154963 AYP# 169416 / 169417 Bunton# PI7994 Dixon# 5961 Encore# 523030 Murray# 94927 / 6201-316 Scag# 481687 Snapper# 3-5658 / 35658 Yazoo# 101768	 
<b>430-658</b>	<b>Plunger Interlock Switch</b> - Single pole, snap in mount. Normally open
<b>O.E.M. Applications</b>	
Ariens# 30957 AYP# 109869X Bobcat# 38383 Exmark# 513152 / 1-513152 Ferris# 21769 John Deere# AM108483 Kees# 923408 Snapper# 2-7225 / 27225	 

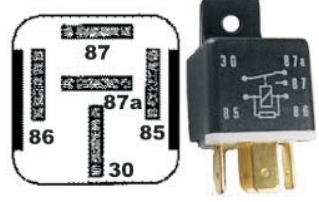

**SWITCHES - Multi Application**

Part#	Application
<b>430-660</b>	<b>Plunger Interlock Switch - Single pole, snap in mount. Normally open</b>
<b>O.E.M. Applications</b>	 <p>Ariens# 36571 / 03657100                      Exmark# 513051                      Ferris# 21451                      John Deere# AM104884                      MTD# 725-1657A / 925-1657A                      Murray# 24273                      Scag# 481637                      Troy Bilt# 1748723                      Yazoo# 1923-025</p>
<b>430-659</b>	<b>Plunger Interlock Switch - Double pole, Normally open / normally closed</b>
<b>O.E.M. Applications</b>	 <p>Ariens# 088281 / 08828100                      AYP# 109553X                      Bobcat# 108208                      Bush Hog# 99073                      Dixon# 4242                      Encore# 523034                      Exmark# 633111 / 1-633111                      Ferris# 22095                      John Deere# AM128925                      Kees# 101080                      MTD# 725-3169A / 925-3169A                      Snapper# 2-3355 / 23355                      Troy Bilt# 1751328                      Woods# 071148</p>
<b>430-665</b>	<b>Plunger Interlock Switch - Double pole, snap in mount. Normally open / normally closed</b>
<b>O.E.M. Applications</b>	 <p>AYP# 153664                      AYP# 176138                      Cub Cadet# 725-3164A                      Cub Cadet# 925-3164A                      Ferris# 22182                      MTD# 725-3164A                      MTD# 925-3164A                      Snapper# 2-2886 / 22886</p>
<b>430-663</b>	<b>Plunger Interlock Switch - Single pole, right angle snap mounted, Normally open</b>
<b>O.E.M. Applications</b>	 <p>Ariens# 27541                      Ariens# 02754100                      AYP# 160784                      Cub Cadet# 725-3167                      Cub Cadet# 925-3167                      Great Dane# D38001                      John Deere# Am103119                      Kubota# K1122-62282                      MTD# 725-3167 / 925-3167                      Murray# 57211 / 024273                      Scag# 48717 / 481638                      Snapper# 1-5707 / 15707                      Toro# 82-2190</p>

**SWITCHES - Multi Application**

Part#	Application
<b>435-369</b>	<b>Relay for AYP - Fits several AYP riders. Open to run</b>
<b>O.E.M. Applications</b>	 <p>Ariens# 03042800                      AYP# 109748X                      Exmark# 1-643275                      Gravely# 040216</p>
<b>430-664</b>	<b>Plunger Interlock Switch - Single pole, right angle snap mounted, Normally closed</b>
<b>O.E.M. Applications</b>	 <p>AYP# 121305X                      Exmark# 740275 / 1-740275                      Husqvarna# 506 90 96-01                      John Deere# AM104403                      MTD# 725-3166                      MTD# 925-3166                      Murray# 94159                      Scag# 48717</p>
<b>430-733</b>	<b>Headlight Switch for AYP - Fits AYP riders.</b>
<b>O.E.M. Applications</b>	 <p>AYP# 110712X                      AYP# 110721X</p>
<b>430-742</b>	<b>Stop Switch for Briggs - Fits Briggs &amp; Stratton 4, 5.5 and 9 Hp Vanguard and 5 Hp Industrial Plus engines.</b>
<b>O.E.M. Applications</b>	 <p>B&amp;S# 495098                      B&amp;S# 495098S</p>
<b>430-666</b>	<b>Twist Lock Seat Switch - Single pole, twist lock mount. Normally closed</b>
<b>O.E.M. Applications</b>	 <p>Bolens# 1768882                      John Deere# AM119943                      Snapper# 292112</p>

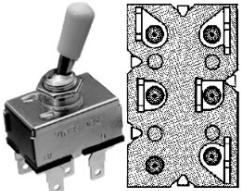
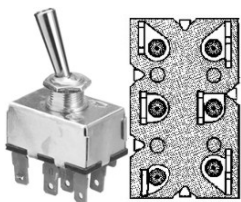
**SWITCHES - Multi Application**

Part#	Application
<b>430-508</b>	<b>PTO Switch - (2) position, (5) terminals.</b> Fits Gravelly models Pro Master 200, 300 & tractor models. John Deere models 318, 420 and 430
<b>O.E.M. Applications</b>	
Bobcat# 128009 Cub Cadet# 725-3022 / 925-3022 Cub Cadet# IH-107372-C1 Gravelly# 45848 / 045848 John Deere# AM39489 Power King# 03-7301 Simplicity# 1675800 Snapper# 1-9545 / 19545 Toro# 37-2610 / 92-6328 Walker# 6950	
<b>430-510</b>	<b>PTO Switch - (2) position, (6) terminals.</b> Fits Ariens 936 series YT tractor models: 936002, 936003, 936004, 936005, 936006, 936008, 936009, 936010, 936011 & 936012.
<b>O.E.M. Applications</b>	
Ariens# 36024 / 03602400 Grasshopper# 184082 Grasshopper# 604796 Scag# 48787 Woods# 70422	
<b>430-496</b>	<b>Safety Switch - 9/16" mounting stem.</b> Normally closed, neutral safety
<b>O.E.M. Applications</b>	
Gravelly# 34640 / 034640 Scag# 48021 Simplicity# 1654634 Toro# 28-4250	
<b>430-494</b>	<b>Safety Switch - 9/16" mounting stem.</b> Normally open, (2) terminal
<b>O.E.M. Applications</b>	
Ariens# 29131 Encore# 363027 / 363207 Gravelly# 20916 / 020916 John Deere# AM37643 Murray# 23479 Scag# 48231 Snapper# 1-6155 / 16155	
<b>430-613</b>	<b>Stop Switch - Fit most Honda engines,</b> 3/4" mounting stem, on/off indicator on plate, Fits models GX110, GX120, GX140, GX160, GX200, GX240, GX270, GX340 and GX390.
<b>O.E.M. Applications</b>	
Honda# 36100-ZE1-015 Honda# 36100-883-005	

**SWITCHES - Multi Application**

Part#	Application
<b>430-661</b>	<b>Plunger Interlock Switch - Double pole,</b> snap in mount. Normally open / normally closed
<b>O.E.M. Applications</b>	
MTD# 725-1657A MTD# 925-1657A	
<b>430-116</b>	<b>Safety Switch - 15/32" mounting stem,</b> Open to run (black button), normally open Fit electric start MTD riders.
<b>O.E.M. Applications</b>	
MTD# 725-0268 / 925-0268 MTD# 725-0277 / 925-0277 Noma# 41204	
<b>430-124</b>	<b>Safety Switch - 15/32" mounting stem,</b> Closed to run (red button), normally closed Fit recoil start models.
<b>O.E.M. Applications</b>	
MTD# 725-0269 MTD# 925-0269	
<b>430-382</b>	<b>PTO Switch - For MTD riders.</b> Fits models 698 and 699.
<b>O.E.M. Applications</b>	
MTD# 725-0803C / 925-0803C	
<b>430-662</b>	<b>Plunger Interlock Switch - Double pole,</b> snap in mount. Normally open / normally closed
<b>O.E.M. Applications</b>	
Murray# 94136	
<b>430-027</b>	<b>Stop Switch - Fits on Stihl Chain Saws and</b> Cut Quik saws.
<b>O.E.M. Applications</b>	
Stihl# 1121-430-0200	

